

Vetro Expo s.r.l.

BLOCK LOCK

FAI-DA-TE

PULITO, VELOCE, SEMPLICE

Distributore per l'Italia

**BLOCK
LOCK**
ORIGINAL

















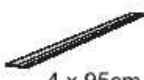

VETRO EXPO
VETRO

VETRO EXPO srl
Via Nazario Sauro, 5
23894 Cremella (LC)

Tel. (+39) 039 9272004
E-mail: commerciale@vetroexpo.it
www.vetroexpo.it

N.B. Il kit BLOCK LOCK si utilizza solo con vetromattoni di misura 19x19x8 cm (*)

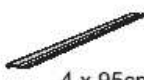
Contenuto delle confezioni - Pareti Lineari

 <p>BlockLock 1m2</p>	 20 x 18cm	 6 x 95cm	 2 x Glue	
 <p>BlockLock 10+ DIY</p>	 4 x 95cm	 1 x Glue		
 <p>BlockLock 10</p>	 11 x 18cm	 4 x 95cm	 3 x Glue	
 <p>BlockLock 20</p>	 10 x 18cm	 11 x 37cm	 4 x 95cm	 4 x Glue
 <p>BlockLock 30</p>	 20 x 18cm	 11 x 57cm	 4 x 95cm	 5 x Glue
 <p>BlockLock 40</p>	 30 x 18cm	 11 x 77cm	 4 x 95cm	 6 x Glue
 <p>BlockLock 50</p>	 40 x 18cm	 11 x 95cm	 4 x 95cm	 7 x Glue



N.B. Il kit BLOCK LOCK si utilizza solo con vetromattoni di misura 19x19x8 cm (*)

N.B. Il kit BLOCK LOCK si utilizza solo con vetromattoni di misura 19x19x8 cm (*)



A

1950 x 200 mm

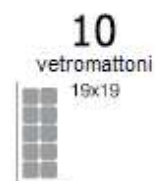

B

975 x 400 mm

10
vetromattoni
19x19



A

1955 x 400 mm

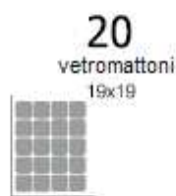

B

975 x 785 mm

20
vetromattoni
19x19



A

1950 x 590 mm

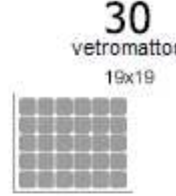

B

975 x 1175 mm

30
vetromattoni
19x19



A

1950 x 785 mm



B

975 x 1565 mm

40
vetromattoni
19x19



A

1950 x 975 mm

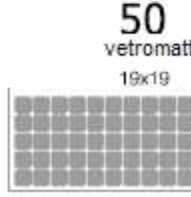

B

975 x 1955 mm

50
vetromattoni
19x19



I VETROMATTONI SONO VENDUTI SEPARATAMENTE

Vetro Expo s.r.l.

N.B. Il kit BLOCK LOCK 360 si utilizza SIA con vetromattoni di misura 19 x 19 x 8 cm CHE di misura 19 x 9 x 8 cm (*)

PARETI CURVE

NUOVO!

360°

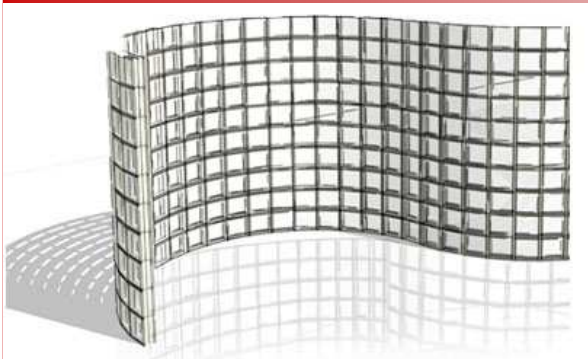

DIMENSIONE DELLA FUGA

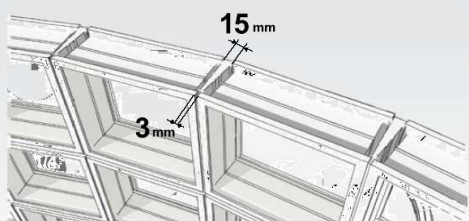

(*) Con i vetromattoni 19 x 9 x 8 cm sono necessari più profili e più colla di quelli forniti nella confezione.

Vetro Expo s.rl.

N.B. Il kit BLOCK LOCK 360 si utilizza SIA con vetromattoni di misura 19 x 19 x 8 cm CHE di misura 19 x 9 x 8 cm (*)



Controllare che vi sia un angolo di 90° tra il pavimento ed il muro.



Applicare la colla al centro del profilo verticale per tutta la sua altezza e applicarlo al muro. Applicare la colla al profilo orizzontale (A) ed attaccarlo al pavimento. Quindi applicare la colla sul profilo orizzontale, sempre al centro, e su quello verticale per un'altezza di 20 cm (D).



Posizionare il primo vetromattone sul profilo orizzontale (A) ed applicare al vetromattone il profilo verticale più corto (B) sul quale sarà stata applicata la colla.



Dopo aver incollato il profilo orizzontale al pavimento, applicare la colla sul lato superiore del profilo orizzontale e su quello verticale per un'altezza di 20 cm.



Posizionare i successivi vetromattoni ripetendo i passaggi 3 e 4. Posizionare i profili verticali (B) e (C) alternandoli.



Applicare la colla e attaccare i profili orizzontali sopra la prima fila di vetromattoni.



(*) Con i vetromattoni 19 x 9 x 8 cm sono necessari più profili e più colla di quelli forniti nella confezione.

Vetro Expo s.r.l.

N.B. Il kit BLOCK LOCK 360 si utilizza SIA con vetromattoni di misura 19 x 19 x 8 cm CHE di misura 19 x 9 x 8 cm (*)



7
Applicare la colla sul profilo orizzontale e per 20 cm su quello verticale. Posizionare la successiva fila di vetromattoni facendoli scivolare fra i profili.



8
Continuare con la fila successiva. Posare i profili verticali (C) dove necessario. Ultimare la fila ripetendo il punto 6.



9
Continuare con la fila successiva. Posare i profili verticali (B) dove necessario. Ultimare la fila ripetendo il punto 6.



10
Applicare la colla sui profili orizzontali e su quelli verticali. Posizionare l'ultima fila di vetromattoni facendoli scivolare fra i profili.



11
Dopo circa 24 ore, quando la parete si sarà asciugata, stuccare con lo stucco specifico per vetromattoni.



12
Il Kit standard "Block Lock 360" creato per 25 vetromattoni (5x5), può essere combinato facilmente per creare pareti più grandi.



(*) Con i vetromattoni 19 x 9 x 8 cm sono necessari più profili e più colla di quelli forniti nella confezione.

Vetro Expo s.r.l.

N.B. Il kit BLOCK LOCK 360 si utilizza SIA con vetromattoni di misura 19 x 19 x 8 cm CHE di misura 19 x 9 x 8 cm (*)



1 SET CONTIENE

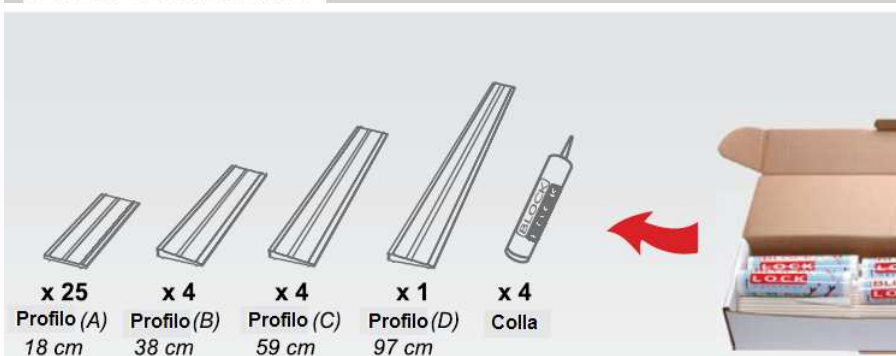

RAGGIO DELLA CURVA

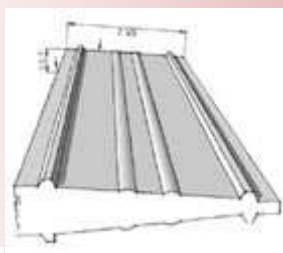
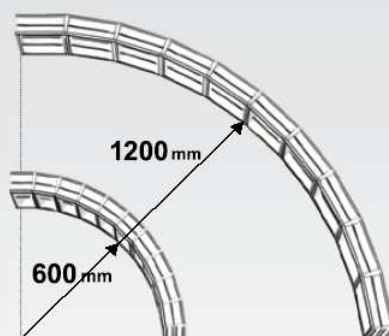
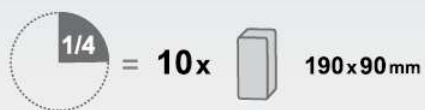

**BLOCK
LOCK**
ORIGINAL

VETRO
EXPO
s.r.l.

VETRO EXPO srl
Via Nazario Sauro, 5
23894 Cremella (LC)

Tel. (+39) 039 9272004

E-mail: commerciale@vetroexpo.it

www.vetroexpo.it

(*) Con i vetromattoni 19 x 9 x 8 cm sono necessari più profili e più colla di quelli forniti nella confezione.

Vetro Expo s.rl.

N.B. Il kit BLOCK LOCK 360 si utilizza SIA con vetromattoni di misura 19 x 19 x 8 cm CHE di misura 19 x 9 x 8 cm (*)

A red square containing a white circle with the number '360' and a degree symbol inside it.

VETRO EXPO
VETRO

VETRO EXPO srl
Via Nazario Sauro, 5
23894 Cremella (LC)

Tel. (+39) 039 9272004

E-mail: commerciale@vetroexpo.it

www.vetroexpo.it

**BLOCK
LOCK**
ORIGINAL

(*) Con i vetromattoni 19 x 9 x 8 cm sono necessari più profili e più colla di quelli forniti nella confezione.